

AXOR Starck Organic
2-handle basin mixer 240 for washbowls with waste set
 Surfaces: **Chrome** Article Number: **12013000**



Description

product features

- consists of: 2-handle basin mixer, waste set
- ComfortZone 240
- projection 124 mm
- shower spray
- swiveling spray former
- flow rate at 3 bar: 3.5 l/min
- flow rate booster: 5 l/min
- ceramic cartridge for temperature control
- ceramic valve for volume control
- temperature limitation adjustable
- separation of temperature and volume control
- with isolated water conduction
- suitable for continuous flow water heaters
- non-closing waste set
- connection dimension: DN15

Technology



Design awards



reddot design award
 best of the best 2013

Product image



Scale drawing

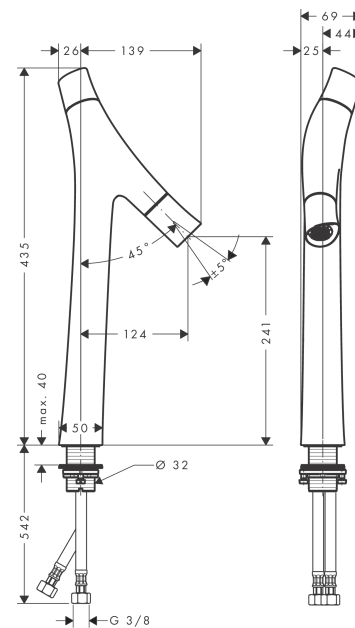

AXOR Starck Organic
2-handle basin mixer 240 for washbowls with waste set
 Surfaces: **Chrome** Article Number: **12013000**



Flowchart

